



Operating Instructions



Let's make things better.



PHILIPS





TABLE OF CONTENTS

Introduction

Safety Information/Useful Tips	3
Before Calling Service	4

Basic Installation/Functions

Hooking Up Your TV (Basic Connection)	5
Use/Care of remote Control	5
Connecting the Audio/Video Sockets (Playback)	6
Connecting the Audio/Video Sockets (Recording)	7
Functions of Remote Control	8
Functions of TV Controls	10

TV Installation

Selecting the Menu Language.....	11
Automatic Tuning of Channels	12
Manual Tuning of Channels	13
Selecting the Colour/Sound System	15
Fine Tuning Of Channels	16
Sorting of Channels.....	17
Editing of Channels.....	18
Naming of Channels.....	19

Features

Adjusting the TV Picture	20
Adjusting the TV Sound	21
Activating the Timer.....	22
Activating the Child Lock.....	24
Using the Screen Format	28
Smart Picture Control	29
Smart Sound Control.....	30
Personal Zapping	31
Automatic Picture Booster	32
Using the Teletext.....	33

General

Specifications.....	35
---------------------	----



Recycling Directive – To minimise harm to the environment, the batteries supplied with the TV set do not contain mercury or nickel cadmium. If possible, when disposing of batteries, use recycling means available to you. Your TV set uses materials which are reusable or which can be recycled. To minimise the amount of waste in the environment, specialist companies recover used sets for dismantling and collection of reusable materials (contact your dealer).





SAFETY INFORMATION AND USEFUL TIPS

Safety Information

- Disconnect mains plug when :
 - the red light below the TV screen is flashing continuously.
 - a bright white line is displayed across the screen.
 - cleaning the TV screen. Never use abrasive cleaning agents. Use a slight damp chamois leather or soft cloth.
 - there is a lightning storm.
 - the set is left unattended for a prolonged period of time.
- No naked flame sources, such as lighted candles, should be placed on top of the TV or in the vicinity.
- Do not place your TV set under direct sunlight or heat.
- Leave at least 5 cm around each side of TV set to allow for proper ventilation.
- Avoid placing your set (e.g. near the window) where it is likely to be exposed to rain or water.
- No objects filled with liquids should be placed on top the TV so as to avoid dripping or splashing of liquids on the set.

Useful Tips

- Do not leave your set on standby mode for a prolonged period of time. Switch off set to allow it to be demagnetised. A demagnetised set supports good picture quality.
- Do not shift or move the set around when it is switched on. Unevenness in colour in some parts of the screen may occur.
- Never attempt to repair a defective TV yourself. Always consult a skilled service personnel.





BEFORE CALLING SERVICE

Below is a list of frequently occurred symptoms. Before you call for service, make these simple checks. Some of these symptoms can easily be rectified if you know what to do.

Symptom

What you should do

Colour patch
(unevenness)

- Switch off the TV by the mains power button. Wait for 20 minutes before switching on again.
- Check the TV is not placed too near speakers or magnetic objects.

No power

- Check the TV's AC power cord is plugged into the mains socket. If there is still no power, disconnect plug. Wait for 60 seconds and re-insert plug. Switch on the TV again.

No picture

- Check the antenna connection at the rear of the TV.
- Possible TV station problem. Try another channel.

Good picture
but no sound

- Try increasing the volume.
- Check that the sound is not muted. If it is muted, press the **Mute** button on the remote control to restore sound.

Good sound but poor
colour or no picture

- Try increasing the contrast and brightness setting.

Snowish picture and
noise

- Check antenna connection at the rear of the TV.

Horizontal dotted lines

- Possible electrical interference e.g. hairdryer, vacuum cleaner, etc. Switch off appliances.

Double images or
"Ghost" images

- Possible poor positioning of antenna. Using a highly directional antenna may improve reception.

TV not responding to
remote control handset

- Check life span of batteries of remote control handset.
- Aim remote control handset directly at remote control sensor lens on the TV.



HOOKING UP YOUR TV (BASIC CONNECTION)

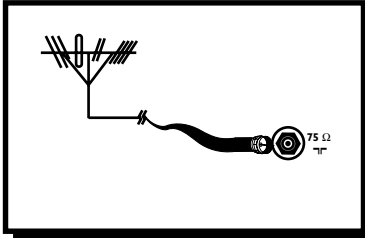

Antenna Connection

- Connect the aerial plug to the antenna socket **T** on the backcover.
- Insert the mains plug into the wall socket.

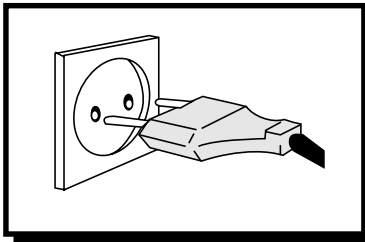

Mains Connection

- For correct mains voltage, refer to type sticker at the rear of the TV set
- Consult your dealer if mains supply is different.
Note :This diagram is not representative of the actual plug and socket.

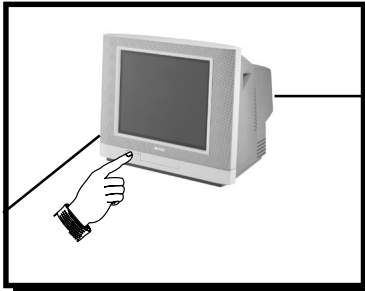

Switching on the Set

- Press the main power button to switch on/off the TV.
- If the set is on standby (indicator is red), press the **Power** button on the remote control to switch on set.

USE/CARE OF REMOTE CONTROL

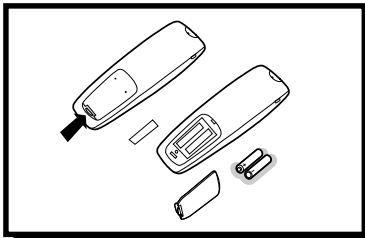

- Insert the correct type of batteries into the compartment.
- Ensure the batteries are placed in the right direction.





CONNECTING THE AUDIO/VIDEO SOCKETS (PLAYBACK)

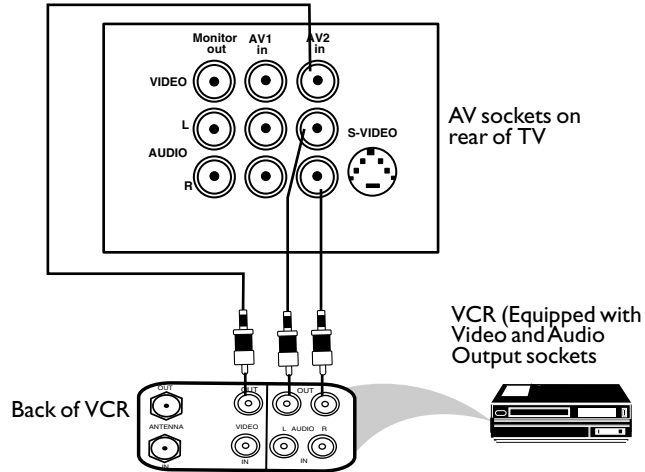

You can view the playback of VCR tapes (Video Disc players, camcorders, etc.) by using the AUDIO and VIDEO INPUT sockets on the rear of the TV.

- Connect the **VIDEO** and **AUDIO IN** sockets on the rear of the TV to the **AUDIO** and **VIDEO OUT** sockets on the VCR.

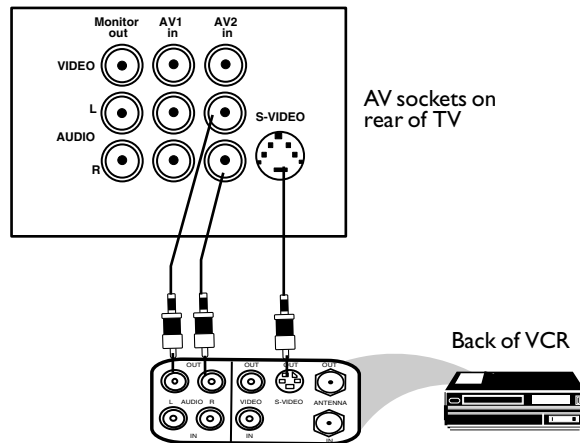

The S-Video connection on the rear of the TV is used for the playback of S-VHS VCR tapes, Video Discs, Video Games or Compact Disc-Interactive (cd-i) discs. Better picture detail and clarity is possible with the S-Video playback as compared to the picture from a normal antenna (RF) connection.

- Connect the **S-VIDEO** socket on the rear of the TV to the **S-VHS OUT** socket on a S-VHS VCR.
- Connect the **AUDIO IN** sockets from the rear of the TV to the **AUDIO OUT** sockets on the VCR. **Note** : You need not connect the **VIDEO IN** socket of the TV if **S-VIDEO IN** socket is connected.





CONNECTING THE AUDIO/VIDEO SOCKETS (RECORDING)

Connection for recording from the TV channel

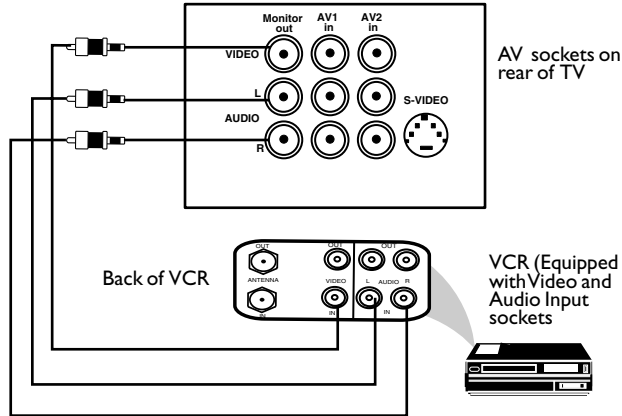

- Connect the corresponding **INPUT** sockets of the VCR to the **MONITOR OUTPUT** sockets on the rear of the TV.
- To enhance the sound of your TV, connect the **AUDIO L** and **R** sockets to an external audio system instead of the VCR. For mono equipment, connect only the **AUDIO L** socket.

Connection for recording from one VCR to another VCR

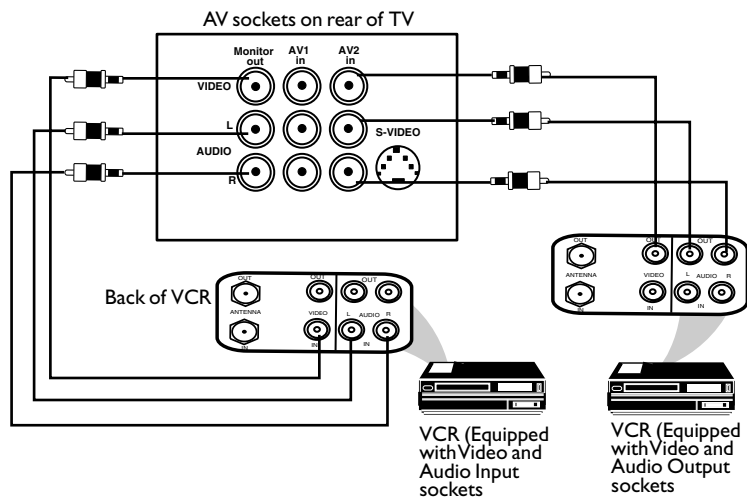

- Connect the sockets of the VCR which you wish to record from, to the corresponding sockets at either **AV1** or **AV2**
- Connect the sockets of the receiving VCR to the **MONITOR OUTPUT** sockets on the rear of the TV.





FUNCTIONS OF REMOTE CONTROL

1 Power button

- Switch set off temporarily to standby mode. (The red light indicator lights up when the set is on standby mode).
- To switch on set from standby mode, press Channel +/- , Digit (0 -9) or Power button.

2 Teletext Colour/Personal Zapping buttons

- In teletext mode, the colour buttons allow you to access directly an item or corresponding pages.
- As Personal Zapping buttons, you can surf up to 10 personal channels for each button. For detailed description of functions, refer to section on “Personal Zapping”.

3 Teletext buttons

Allows you to access teletext information. For detailed description of functions, refer to section on “Using the Teletext”

4 Smiley button

Allows to add and store your personal preference channels in your Personal Preference list. For detailed description of functions, refer to section on “Using your Personal Zapping feature”.

5 Timer Button

Allows you to set the clock to switch to another channel at a specified time while you are watching another channel or when the set is on standby mode.

6 Smart Sound Button

Press the Smart Sound button repeatedly to access 4 different types of sound settings and choose your desired setting.

7 Menu Button

Displays the main menu. Also exits menu from screen.

8 Cursor Up Button

Allows you to select the next item on the menu.

9 Cursor Left Button

Allows you to select the sub-menus and adjust the settings.

10 Volume + / – Button

Increases or decreases volume.

11 II

Allows you to switch from Stereo to Mono sound during stereo transmission or to choose between language I or language II during dual sound transmission.

12 A/CH(Alternate channel) Button

Allows you to change between the current channel and the previous channel.

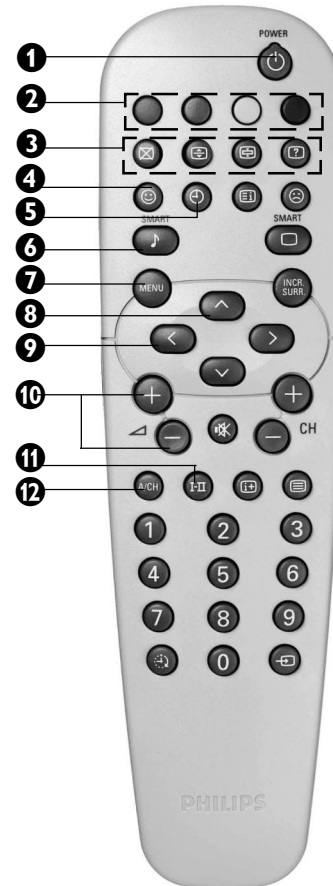



FUNCTIONS OF REMOTE CONTROL

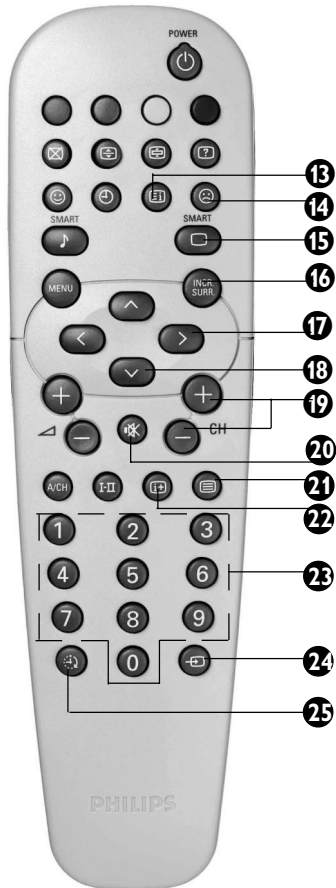

- 13 Main Index Button**
In teletext mode, press button to return to the main index page.
- 14 Frownie button**
Allows to delete stored personal preference channels in your Personal Preference list. For detailed description of functions, refer to section on “Personal Zapping”.
- 15 Smart Picture Button**
Press the Smart Picture button repeatedly to access 5 different types of picture settings and choose your desired setting.
- 16 Incredible Surround Button**
 - Allows you to select Incredible Surround sound when transmission is in stereo mode.
 - Allows you to select Spatial Sound when transmission is in mono mode.
- 17 Cursor Right Button**
Allows you to access the sub-menus and adjust the settings.
- 18 Cursor Down Button**
Allows you to select the next item on the menu.
- 19 Channel + / - Buttons**
Allows you to select channels in ascending or descending order.
- 20 Mute Button**
Mutes sound. To restore sound, press button again.
- 21 Teletext Button**
Refer to section on “Using the Teletext”
- 22 OSD button**
Allows you to display the current channel number. It also allows to exit menu from the screen after control adjustments.
- 23 Digit (0 -9) Buttons**
Press to select a channel. For a 2-digit channel number, press the first digit and followed immediately by the second digit.
- 24 A/V Button**
Allows you to select the AV channels.
- 25 Sleeptimer Button**
Allows you to select a time period after which the set will switch to standby mode automatically.





FUNCTIONS OF TV CONTROLS

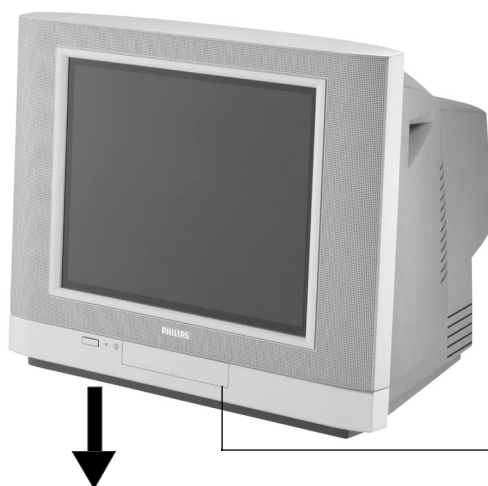

Push catch of lid upwards to open front controls cover

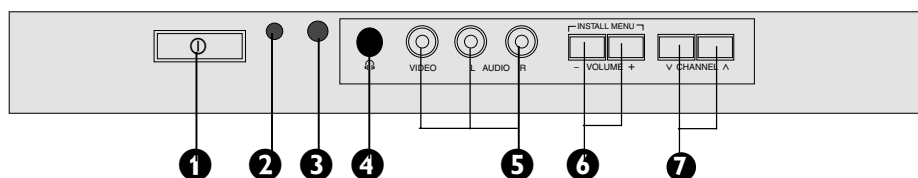

❶	Mains Power button	Switch mains power on or off.
❷	Standby light indicator	Indicate red light when standby mode is activated.
❸	Remote Sensor	Acts as a sensor for activating the controls of the TV when remote control handset is aimed at it.
❹	Headphone socket	Connect headphone jack to socket for personal listening.
❺	AV "in" sockets	Connect to Video "out" and Audio "sockets" to VCR, VCD, etc. (For more details on connection, refer to section "Connecting the Audio/Video Sockets").
❻	Volume - / + buttons	Adjust sound volume softer/louder.
❼	Channel V / ^ buttons	Select channel in ascending/descending order.

Note

- You can enter the main menu by pressing both the **Volume -** and **+** buttons at the same time.
- Press the **Channel V / ^** button to select the next item on the menu.
- Press **Volume - / +** button to access sub-menu and adjust the settings.





SELECTING THE MENU LANGUAGE

Operating instructions generally explains the operation of the TV set using the buttons on the remote control unless otherwise stated. Please read the following instructions carefully and follow the steps as shown to familiarise yourself with the installations and all features available in your set.

The **Language** feature allows you to set the TV's on-screen menu to be shown in your desired language.

Step

Press button

Result on TV Screen

1



Enter main menu.

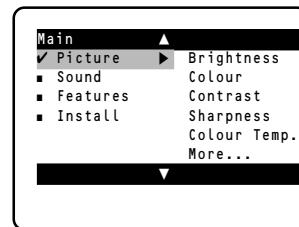

2



Select **Install**.

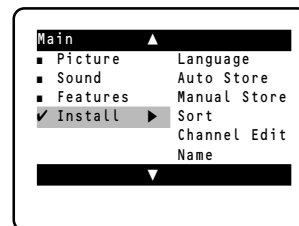

3



Enter the Install menu.



4



Press button repeatedly to cycle through the language list and select the language of your choice.

5



Exit menu from screen.





AUTOMATIC TUNING OF CHANNELS

Automatic tuning of channels allows you to store each programme automatically.

Step	Press button	Result on TV Screen
1	Enter main menu.	
2	Press button repeatedly until Install is selected.	
3	Enter install menu.	
4	Select Auto Store .	
5	Start automatic tuning of channels.	
6	When tuning is completed, exit menu from screen.	





MANUAL TUNING OF CHANNELS

Manual tuning of channels allows you to select your preferred channel number for every available programme.

Step

Press button

Result on TV Screen

1



Enter main menu.

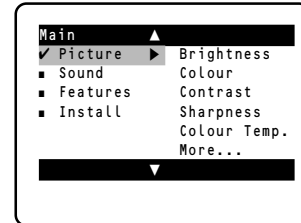

2



Press button repeatedly until **Install** is selected.

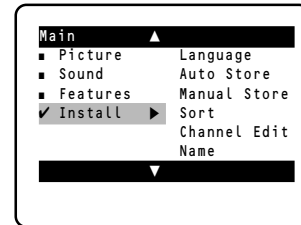

3



Enter install menu.

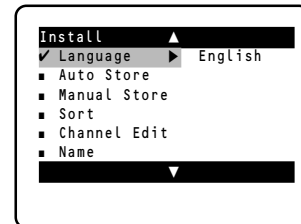

4



Press button repeatedly until **Manual Store** is selected.

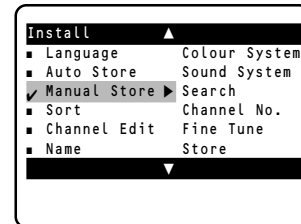

5



Enter manual store menu.

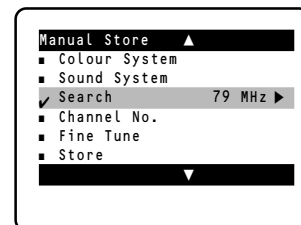

6



Press button repeatedly until **Search** is selected.



MANUAL TUNING OF CHANNELS

Step	Press button		Result on TV Screen
		Start manual searching. Searching stops once a transmitting signal is found.	
		Select Channel .	
		Key in the channel number.	
		Press button repeatedly until Store is selected.	
		Store tuned channel. Note : If you want to continue searching for another transmitting channel, repeat steps 7 to 11.	
		Exit menu from screen.	





SELECTING THE COLOUR/SOUND SYSTEM

This feature allows you to select your desired **Colour** and **Sound** system. If **Auto** is selected, the respective colour and sound system will be automatically selected according to the transmission system. **Note** : Select your desired colour and sound system manually if reception is poor at **Auto** mode.

Step

Press button

Result on TV Screen

Repeat **step 1** to **step 5** as in “**Manual Tuning of TV Channels**”

Colour System is selected.

6

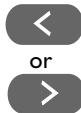

Select the desired colour system (**Auto, PAL, NTSC 3.58, NTSC 4.43** or **SECAM**).

7



Press button repeatedly until **STORE** is selected.

8



Store selected system.

9

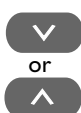

Proceed to select **Sound System**.

10

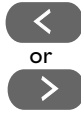

Select the desired sound system (**Auto, BG, I, DK** or **M**).

11



Press button repeatedly until **STORE** is selected.

12



Store selected system.

13



Exit menu from screen.

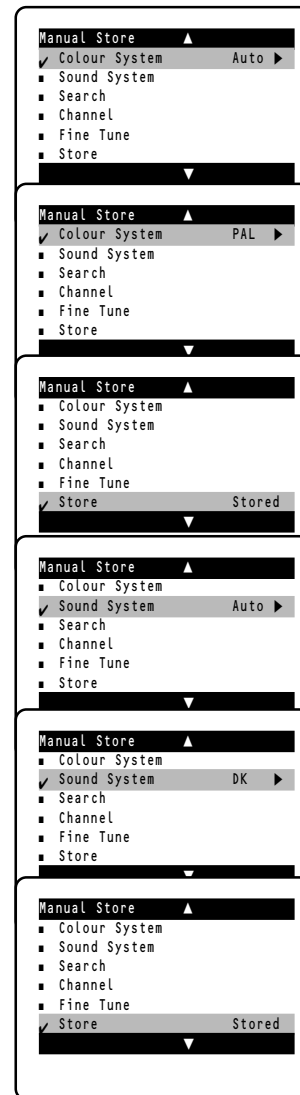



FINE TUNING OF CHANNELS

This feature allows you to adjust picture reception in areas of weak reception.

Step	Press button	Result on TV Screen
1	MENU	
2	↓	
3	→	
4	↓	
5	→	
6	↓	
7	→ or ←	
8	↓	
9	→	
10	EXIT	





SORTING OF CHANNELS

This feature rearranges channel numbers.

Step

Press button

Result on TV Screen

1



Enter main menu.

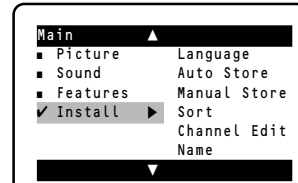

2



Press button repeatedly until **Install** is selected.

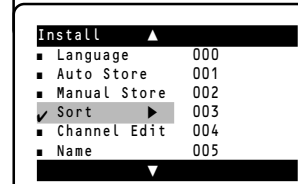

3



Enter install menu.

4



Press button repeatedly until **Sort** is selected.

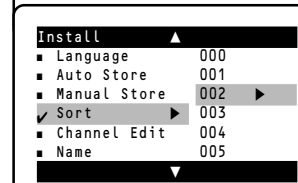

5



Enter sort mode.

6



Select the channel number you want to change from (e.g. 002).

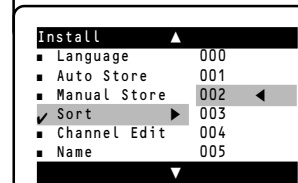

7



Confirm selection.

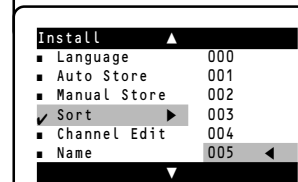

8



Select the channel number you want to change to (e.g. 005).

9



Confirm selection.

The change is done.

Note : Channel numbers 5, 4 and 3 will move upwards accordingly. that is, Channel 5 will move up to Channel 4, Channel 4 to 3 and Channel 3 to 2.

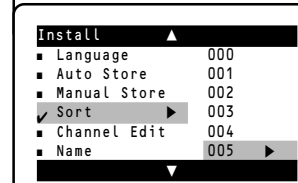

10



Exit menu from screen.





EDITING OF CHANNELS

This feature allows you to skip or edit channels which have bad or weak TV signal or channels that you do not watch often. **Note** : Once a channel is skipped, you cannot have access to it by the CH (Channel) + or – button. You can only have access to the channel by the Digit (0 -9) buttons.

Step	Press button	Result on TV Screen
1	Enter main menu.	
2	Press button repeatedly until Install is selected.	
3	Enter install menu.	
4	Press button repeatedly until Channel Edit is selected.	
5	Enter Channel Edit menu.	
6	Key in the channel number to be skipped.	
7	Select Skipped .	
8	Select On to skip channel.	
9	Exit menu from screen.	

HOW TO RESTORE SKIPPED CHANNELS

- Repeat **Steps 1 to 5** as in "Editing of Channels".
- Key in the channel number to be restored by the **Digit (0 - 9)** button.
- Select **Skipped** by the **Cursor Down** button.
- Select **Off** to restore channel by the **Cursor Right** button.
- Exit menu from screen by the **OSD** button.

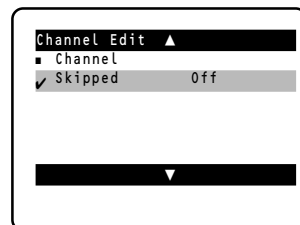



NAMING OF CHANNELS

This feature enables you to name or rename channels.

Step	Press button	Result on TV Screen
1	Enter main menu.	
2	Press button repeatedly until Install is selected.	
3	Enter install menu.	
4	Press button repeatedly until Name is selected.	
5	Enter name mode.	
6	Select the channel you want to name. or 	
7	Move to first character slot.	
8	A cursor appears for you to start the input of characters. Select the character you want. Move to next character slot by the Cursor Right button and select the next character. You can enter up to a maximum of 5 characters. After naming the channel, press Cursor Right button repeatedly until name appears on the top left hand corner of the screen. or 	
9	Exit menu from screen.	



ADJUSTING THE TV PICTURE

The picture menu allows you to make adjustments to the picture.

Step	Press button	Result on TV Screen
1	Display the main menu on screen.	
2	Enter Picture menu.	
3	Select item. or 	
4	Adjust level or select desired setting. or 	
5	Exit menu from screen.	

Picture menu items	Activities
Brightness	Increase or decrease brightness level.
Colour	Increase or decrease color level.
Contrast	Increase or decrease contrast level.
Sharpness	Increase or decrease sharpness level to improve detail in picture.
Color temperature	Choose from 3 settings (Normal, Warm or Cool).
NR (Noise Reduction)	Select "On" to reduce "noisy" picture (little dots on picture) due to weak signal.
Contrast +	Select "On" to allow you to optimise the total contrast for improved picture quality.





ADJUSTING THE TV SOUND

The sound menu allows you to make adjustments to the sound.

Step	Press button	Result on TV Screen
1	Display the main menu on screen.	
2	Select Sound menu.	
3	Enter Sound menu.	
4	or Select item.	
5	or Adjust level or select desired setting.	
6	Exit menu from screen.	

Sound menu items	Activities
Treble	Increase or decrease high frequency level.
Bass	Increase or decrease low frequency level.
Balance	Increase or decrease to adjust balance level.
AVL (Auto Volume Leveller)	Select On to enable volume to remain at a pre-determined level should there be a sudden change in volume during commercial breaks or channel switching.
Incredible Surround	Select between Mono and Spatial sound when transmission is in Mono and between Stereo and Incredible Surround sound when transmission in Stereo.
Ultra Bass	Select On to enjoy enhanced bass output.





USING THE TIMER

The Timer feature allows you to set the timer to switch to another channel at a specified time while you are watching another channel or when the TV is on standby mode.

Note : For the timer to function, the set must not be switched off. Once the set is switched off, the timer is disabled.

Step	Press button	Result on TV Screen
1	Display the main menu on screen.	
2	Select Features .	
3	Enter the Features menu.	
4	Enter Timer menu.	
5	Key in the current time starting from the hour follow by minute. This is the time where the "start time" and "stop time" will take reference from.	
6	Select Start Time .	
7	Key in the time you want the programme to be switched on.	





USING THE TIMER

Step	Press button		Result on TV Screen
		Select Stop Time .	
		Key in the time you want the programme to be switched off.	
		Select Channel .	
		Key in the channel you want to switch to.	
		Select Activate .	
		Activate timer. You can select Once, Daily or Off .	
		Select Display .	
		Select On mode if you want to display the time on the TV screen.	
		Exit menu from screen.	

Note :

- After the Stop Time is activated, the TV will go to standby mode immediately.
- If Stop Time is not keyed in, the set will go to standby mode after 2 hours.
- To switch on set from standby mode, press **Channel +/-**, **Digit (0 -9)** or **Power** button.





ACTIVATING THE CHILD LOCK (ACCESS CODE)

The Child Lock feature allows you to lock channels to prevent your children from watching programmes you deem undesirable.

Note : You can only have access to the locked channels via the remote control. Keep the remote control out of reach so as to prevent your children from having access to it.

Step	Press button		Result on TV Screen
1		Display the main menu on screen.	
2		Press button repeatedly until Features is selected.	
3		Enter the Features menu.	
4		Select Child Lock .	
5		Enter Child Lock mode.	
6		Key in the 4-digit access code. For the first time or if you have forgotten the access code, enter the universal access code 0711 twice. It will now prompt you to key in a New Code .	
7		Key in your preferred code (4-digit).	
8		Key in the new code the second time to confirm code.	
9		The Child Lock menu will now appear. You can proceed to lock channel (refer to section on "Lock Channel"). If not, exit menu from screen.	

Note : After you have exit menu from screen and you want to enter the child lock menu again, you need to key the new access code only once.





ACTIVATING THE CHILD LOCK (CHANGE CODE)

Note : You need to key the access code only once.

Step

Press button

Result on TV Screen

Repeat **Steps 1 to 8** as in **“ACTIVATING THE CHILD LOCK (ACCESS CODE)”**

The Child Lock menu will now appear. You can proceed to change code.

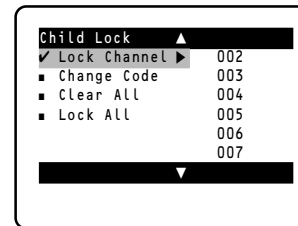

Select **Change Code**.

Enter change code mode.

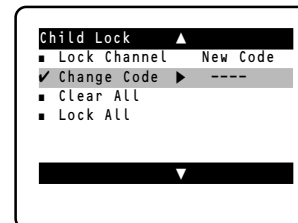

Key in your preferred code (4-digit).

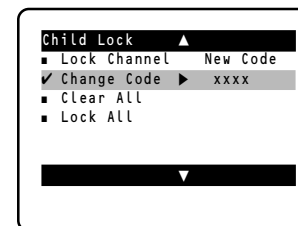

Key in the new code the second time to confirm code.

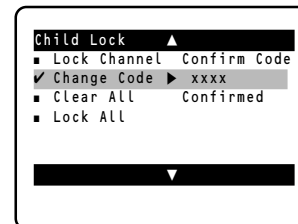

Exit menu from screen.

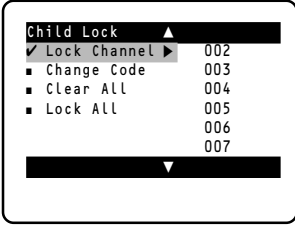
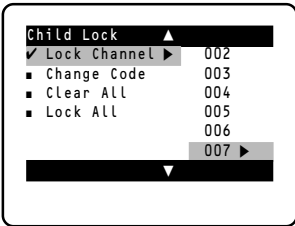
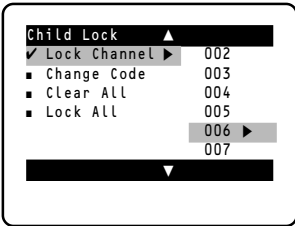
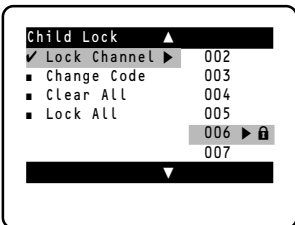

ACTIVATING THE CHILD LOCK (LOCK CHANNEL)

Step	Press button		Result on TV Screen
		Repeat Steps 1 to 8 as in “CHILD Lock (ACCESS CODE)”	The Child Lock menu will now appear. You can proceed to lock channel.
			
9		Enter lock channel mode.	
10	 or 	Select the channel you want to lock.	
11		Activate blocking of channel. A keylock symbol will appear beside the channel number indicating that it is locked. Note : To lock more than one channel, repeat Steps 10 to 11 before exiting menu from screen.	
12		Exit menu from screen.	





ACTIVATING THE CHILD LOCK (LOCK ALL)

You can choose to lock all channels in the **Lock All** mode in the Child Lock menu.

Step

Press button

Repeat **Steps 1 to 8** as in “**CHILD Lock (ACCESS CODE)**”

The Child Lock menu will now appear. You can proceed to lock all channels.

Result on TV Screen

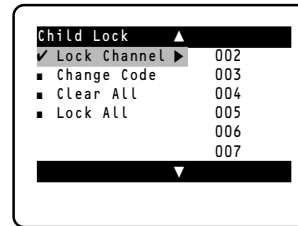

9



Select **Lock All**.

10



Select the **On** option to lock all channels.

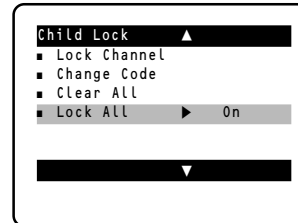

11



Exit menu from screen.

ACTIVATING THE CHILD LOCK (CLEAR ALL)

To unlock channels that you have locked, enter the Child Lock menu and select the **Off** option **Clear All** mode.

Step

Press button

Repeat **Steps 1 to 8** as in “**CHILD Lock (ACCESS CODE)**”

The Child Lock menu will now appear. You can proceed to clear all channels.

Result on TV Screen

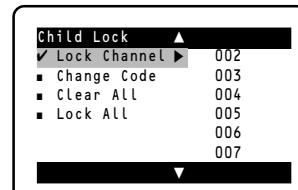

9



Select **Clear All**.

10



Select the **Off** option to unlock all channels.

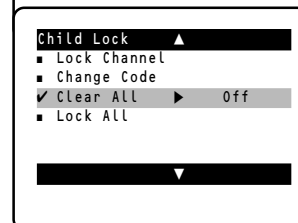

11



Exit menu from screen.





USING THE SCREEN FORMAT

You can have a choice of two formats for your viewing pleasure, namely : - **4:3** mode and the **EXPAND 4:3** mode through the **FORMAT** menu.

Step	Press button	Result on TV Screen
1	MENU	Display the main menu on screen.
2		Press button repeatedly until Features is selected.
3		Enter the Features menu.
4		Press button repeatedly until Format is selected.
5		Press the button repeatedly to cycle through the different formats (4:3 or Expand 4:3) and select your desired format.
6		Exit menu from screen.

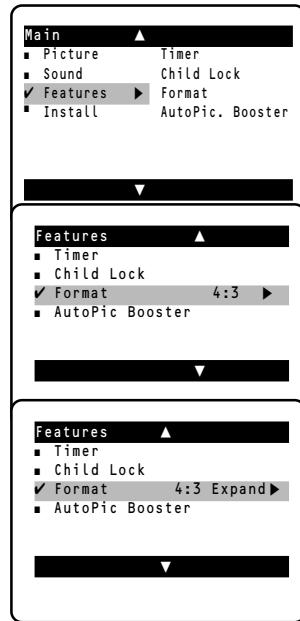

When to use the Screen Formats

4:3 format

Select the 4:3 format if you want to display the 4:3 picture using the full surface of the screen.

Expand 4:3 format

Select the Expand 4:3 format if you want to expand movie images recorded in the letterbox format. When this format is selected, the black horizontal bars at the top and bottom are expanded thus filling up the entire TV screen.

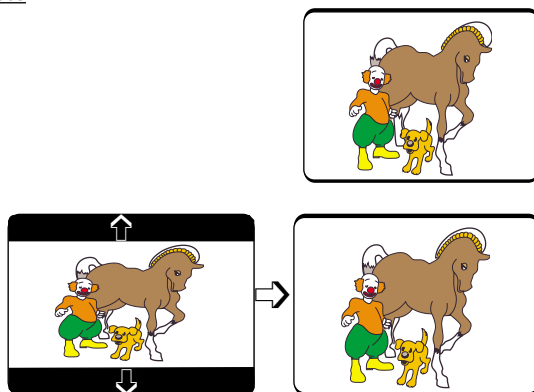



SMART PICTURE CONTROL

Whether you are watching a movie or video game, your TV has automatic video control settings matched to your current program source or content. The Smart Picture feature quickly resets your TV's video controls of program for a number of different types of programs and viewing conditions you may have in your home. Each Smart Picture setting is preset at the factory to automatically adjust the TV's Brightness, Colour, Picture and Sharpness levels.

Step Press button

1



Press button repeatedly to cycle through the 5 settings namely, **DVD/VCD, Rich, Natural, Soft** and **Personal** and select your desired picture setting.

2



Exit menu from screen.

Defintion of Picture Settings

DVD/VCD : For optimal picture setting, whenever the source is connected to DVD/VCD player, select DVD/VCD setting for AV mode.

Rich : Emphasize very vibrant colours. This setting is the optimal setting when you are viewing TV programmes in a brightly-lit room.

Natural : Emphasize original colours.

Soft : Emphasize "warm" colours. (Suitable for dimly-lit room condition and gives cinema-like effect when light is switched off).

Personal : Picture settings are set to your preference.

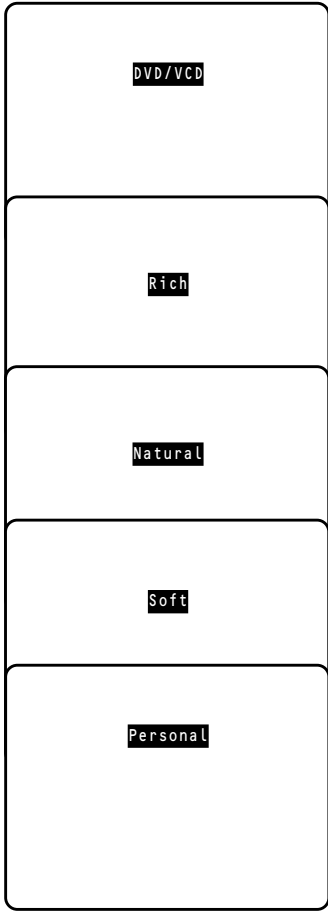



SMART SOUND CONTROL

Whether you are watching a movie or video game, your TV has automatic sound control settings matched to your current program source or content. The Smart Sound feature quickly resets your TV's sound controls of program for a number of different types of programs and viewing conditions you may have in your home. Each Smart Sound setting is preset at the factory to automatically adjust the TV's Treble and Bass levels.

Step

Press button

1



Press button repeatedly to cycle through the 4 settings namely, **Theatre**, **Music**, **Voice** and **Personal** and select your desired sound setting.

2



Exit menu from screen.

Definition of Sound Settings

Theatre : Emphasize sensation to action.
(Bass and Treble boosted)

Music : Emphasize low tone (Bass boosted).

Voice : Emphasize high tone (treble boosted).

Personal : Sound settings are set to your preference.

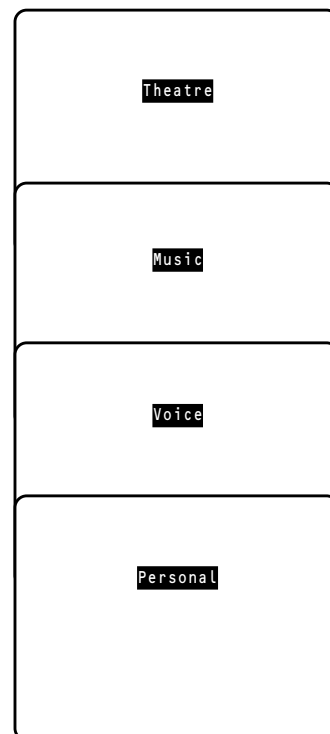



PERSONAL ZAPPING

A list or series of favourite TV programs can be selected and stored in the 4 coloured buttons with the Personal Zapping feature. With this feature you can easily viewed up to a total of 10 preferred channels for each coloured button.

Adding Channels to the Favourite list

Step	Press button		Result on TV Screen
		Select a channel by the Digit buttons	
		Press button to display list. Choose your favourite colour button to store selected channel.	
		Repeat steps 1 to 3 to add and store your favourite channels to the list.	
		Exit menu from screen.	

To view through the favourite list

- Press the colour button that you have selected.
- Press button repeatedly to cycle through your favourite list and view your favourite channel.

Deleting Channels from the Favourite list

		Select a colour button and press button repeatedly to select the channel you want to delete.	
		Press button to display list.	
		Press button to remove item. Repeat steps 1 to 3 to delete more channels from list.	
		Exit menu from screen.	





AUTOMATIC PICTURE BOOSTER

If the transmission signal is weak, the Automatic Picture Booster built into the TV set will increase the signal level to provide a good picture at all times. You have a choice to turn on/off the feature, depending on the signal conditions locally.

Step	Press button		Result on TV Screen
1		Display the main menu on screen.	
2		Select Features .	
3		Enter the Features menu.	
4		Select Auto Pic. Booster .	
5		Select On .	
6		Exit menu from screen.	





USING THE TELETEXT

If a TV channel broadcast contains teletext information, each channel that broadcasts teletext transmits a page (index page) with information on how to use the teletext system, usually on page 100. The system transmitted is indicated in the option line at the bottom of the screen.

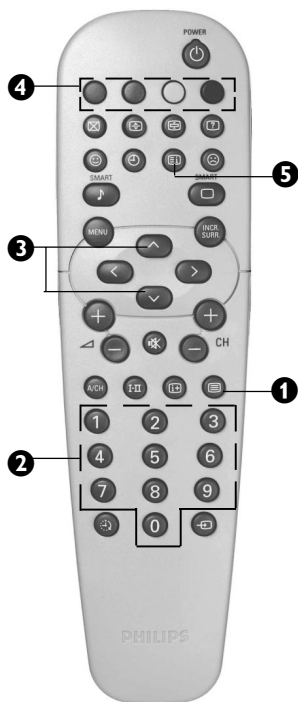

Press button

Result on TV Screen

- 1 On/Off teletext and Superimpose teletext page over TV programme**

Press the button once to switch on teletext display. (A channel in which teletext is being transmitted must be selected). Press the button the second time superimpose the teletext page over the TV programme. Press the button the third time to exit teletext mode.



- 2 Selecting a teletext page**

Key in the required teletext page (3 digits). The page number is displayed at the top left hand corner of the screen. When the teletext page is located, the counter stops searching. If the counter keeps searching, it means that the page is not available for selection. If you make a mistake in keying the page number, you have to complete keying the 3-digit number before re-keying the correct page number.

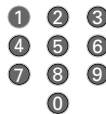

- 3 Accessing a teletext page**

Press the **CURSOR UP** button to display the next page and the **CURSOR DOWN** button to display the previous page.



- 4 Direct Access to an item or corresponding pages**

The 4-colour buttons allow you to access directly an item or corresponding pages.



- 5 Main Index**

Press the button to return to the main index page.





USING THE TELETEXT



Press button

Result on TV Screen

6 Interrupt



Press the button to change to TV mode. Press the button again to return to teletext mode and to the teletext page.

7 Enlarge



Press the button once to enlarge and view the top half of the page. Press the button the second time to enlarge and view the bottom half of the page. Press the button the third time to return to normal size page.

8 Hold



A selected page sometimes contains a few sub-pages. The sub-page will automatically move to the next sub-page after about 20 seconds. The total number of sub-pages are indicated at the top right hand corner of the screen. Press the button once to hold page and the second time to release holding of page.

9 Reveal/Conceal



Press the button once to reveal hidden information (solutions to puzzles, riddles, etc). Press the button the second time to conceal information. This button is applicable only to teletext page with puzzles, riddles, etc.)





SPECIFICATIONS

	15PT2302
Picture tube screen size	370 mm
Picture tube visible area	355 mm
Audio Output : Speaker	2 x 3 W
TV System	NTSC M PAL B/G PAL D/K PAL I SECAM B/G SECAM D/K SECAM K1
Set Dimensions : Width Depth Height	403 mm 444 mm 357 mm
Net Weight of Set	approximate 13 kg

Note

For Operating Voltage, Frequency, Power Consumption and Version Number, refer to the type number at the rear of the set.